

Panasonic®

Hybrid IP-PBX Information about IP Proprietary Telephones

Model **KX-TDA100**
KX-TDA200/KX-TDA600



Thank you for purchasing a Panasonic Hybrid IP-PBX.
Please read this manual carefully before using this product and save this manual for future use.

KX-TDA100/KX-TDA200: PMPR Software File Version 3.0000 or later
KX-TDA600: PLMPR Software File Version 3.0000 or later

Document Version: 2006-04

Table of Contents

1	Introduction	3
1.1	Overview	4
1.1.1	Using the IP Proprietary Telephones on the Local Office LAN	4
1.1.2	Using IP Proprietary Telephones on the Local and Remote Office LANs	6
1.2	Network Management	8
1.2.1	DHCP (Dynamic Host Configuration Protocol) Server	8
1.2.2	VLAN (Virtual LAN)	9
2	Guidance for VoIP Installation	11
2.1	VoIP Requirements	12
2.1.1	Bandwidth Assessment	12
2.1.2	Network Configuration	12
2.1.3	Network Devices	15
2.2	VoIP Requirements Checklist	17
3	Installation	19
3.1	Installing the IP-EXT16 Card in the Hybrid IP-PBX	20
3.1.1	Names and Locations	20
3.1.2	Installation	21
3.2	Connecting to the LAN	23
3.2.1	Connecting the IP-EXT16 Card	23
3.2.2	Connecting the IP Proprietary Telephones	25
4	Programming	29
4.1	Programming the IP-EXT16 Card	30
4.1.1	Assigning the IP Addressing Information	30
4.2	Programming the IP Proprietary Telephone	32
4.2.1	Assigning the IP Addressing Information	32
4.2.2	Setting the VLAN Parameters	36
4.3	Registering the IP Proprietary Telephone	38
4.3.1	Registering the IP-PT	38
4.3.2	De-registering the IP-PT	39
A	Troubleshooting	41
A1	Troubleshooting	42
A1.1	Operation	42
A1.2	Error Message	43

Section 1

Introduction

1.1 Overview

1.1.1 Using the IP Proprietary Telephones on the Local Office LAN

Panasonic KX-NT series IP proprietary telephones (IP-PTs) allow voice communication over the data network by converting the voice into data. The following diagram shows a simple Voice over Internet Protocol (VoIP) network using the IP-PTs at the local office.

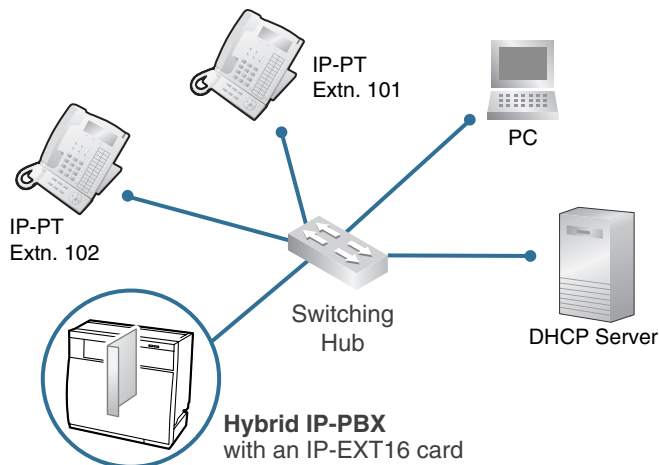

Network Parameters

You will need to have the following IP addressing and VLAN ID information to use IP-PTs on your network. This information is typically supplied by a network administrator.

The numbers in the table below are given as examples. Consult your network administrator for specific values.

Parameter	Description	Example Entry	
		IP-PT Extn. 101	IP-PT Extn. 102
IP-PT IP Address	Identifies the location of IP-PTs on the network. Each IP-PT must have a unique IP address.	192.168.0.101	192.168.0.102
Subnet Mask Address	Defines which digits of an IP address are used for the network address and the host address at each network location. IP addresses of IP-PTs and the IP-EXT card must fall within the same subnet as that of the default gateway (e.g., router) of the LAN.	255.255.255.0	

Parameter	Description	Example Entry	
		IP-PT Extn. 101	IP-PT Extn. 102
Default Gateway Address	Identifies the IP address of the primary gateway (typically a router or similar device) that exchanges IP packets with the other gateways on the VoIP network.	192.168.0.1	
PBX IP Address	Identifies the location of the IP-EXT card with which IP-PTs will communicate.	192.168.0.100	
VLAN ID	Identifies the ID of the logical segment within the corporate LAN, through which voice packets from IP-PTs travel. For details, refer to "1.2.2 VLAN (Virtual LAN)".	1	

1.1.2 Using IP Proprietary Telephones on the Local and Remote Office LANs

By connecting the local office LAN to other LANs at different locations, the IP-PTs on the remote office LANs can be used as extensions of the Hybrid IP-PBX at the local office.

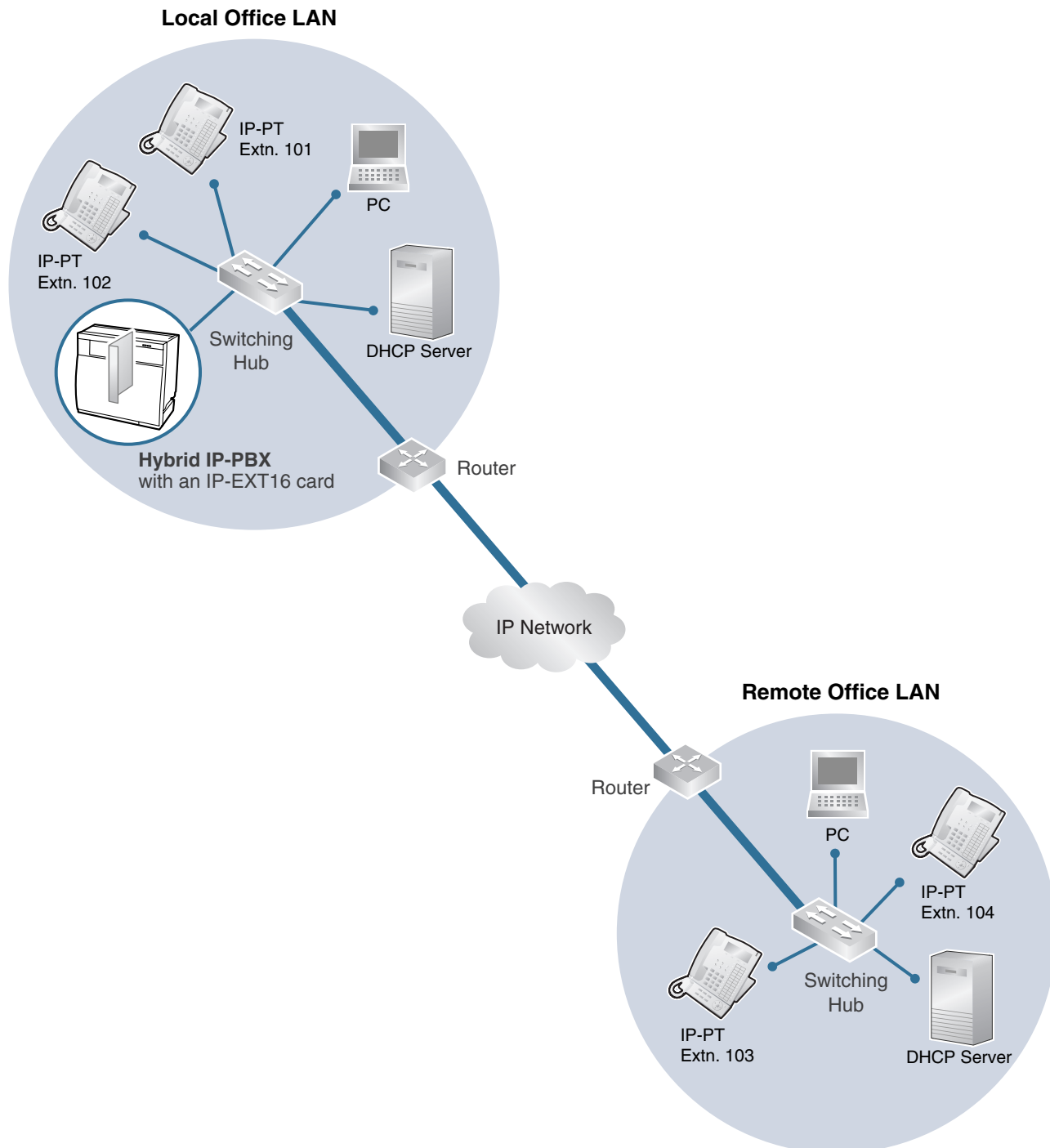

Network Parameters

To use IP-PTs at the remote office, you will need to have the IP addressing and VLAN ID information described in "1.1.1 Using the IP Proprietary Telephones on the Local Office LAN".

Parameter	Local Office		Remote Office	
	IP-PT Extn. 101	IP-PT Extn. 102	IP-PT Extn. 103	IP-PT Extn. 104
IP-PT IP Address	192.168.0.101	192.168.0.102	10.75.0.103	10.75.0.104
Subnet Mask Address	255.255.255.0		255.255.255.0	
Default Gateway Address	192.168.0.1		10.75.0.1	
PBX IP Address	192.168.0.100			
VLAN ID	1			

Types of IP Network

When using IP-PTs over LANs at different locations, first confirm the type of IP network connecting the LANs. The speech quality depends on the type of IP network in use. Managed IP networks provide better speech quality compared to unmanaged networks such as the Internet, where quality of service cannot be guaranteed.

Examples of recommended IP networks

- Digital Leased Line
- IP-VPN (Virtual Private Network)
- Frame Relay

Not recommended

- Internet (including an Internet VPN)

Note

Unlike an IP-VPN, which is set up over a network provider's own IP network, an Internet VPN is set up over the Internet. Internet VPNs are not recommended for IP-PT communications because transmission delays and loss of data are likely occur.

1.2 Network Management

1.2.1 DHCP (Dynamic Host Configuration Protocol) Server

For IP-PTs to communicate over a network, an IP address must be assigned to each IP-PT to identify its locations on the network. While these addresses can be assigned manually at each IP-PT, it is also possible to use a DHCP server.

A DHCP server automatically assigns IP addresses to IP-PTs when they are connected to the network. An IP-PT then use the received IP addresses to register to the IP-EXT16 card.

Using a DHCP server allows you to centrally manage and automate the assignment of IP addresses.

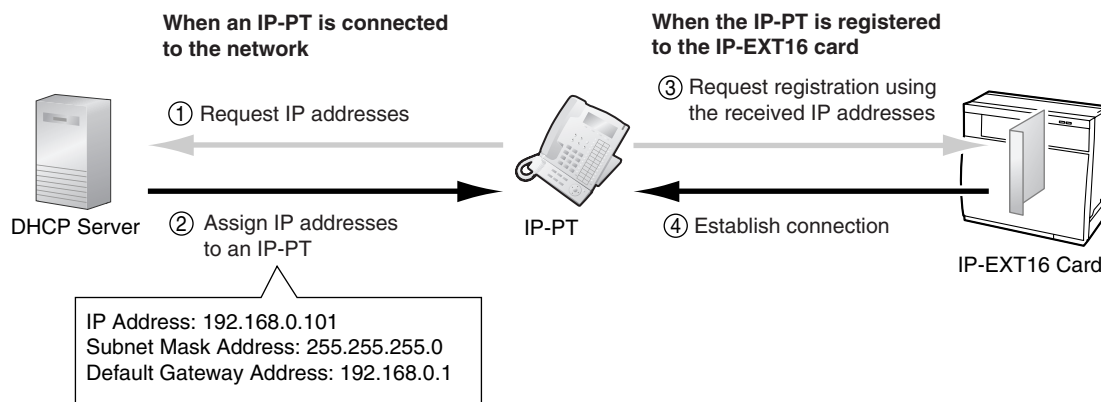

Notes

- The Hybrid IP-PBX is not able to act as a DHCP server. To use the DHCP client function of IP-PTs, a separate DHCP server is required on the network, as shown above.
- The IP address for the IP-EXT16 card cannot be assigned automatically using a DHCP server. This IP address must be assigned manually by using the Maintenance Console (PC programming software of the Hybrid IP-PBX). For details, refer to "4.1 Programming the IP-EXT16 Card".
- An IP-PT cannot request IP addresses from a DHCP server on another LAN (connected through IP network). An IP-PT can only receive IP addresses from a DHCP server on its own LAN. Therefore, when IP-PTs are located on several LANs, a DHCP server is required on each LAN. If a DHCP server is not present on the LAN, IP addresses for IP-PTs on that LAN must be assigned manually.

1.2.2 VLAN (Virtual LAN)

VLANs are logical segments within a corporate LAN. By assigning VLAN settings to IP-PTs, it is possible to separate the packets transmitted by an IP-PT according to the type of data, and specify which VLAN each data type will be sent over. This allows you to avoid generating unnecessary network traffic on each segment, and to reduce the load on the network. As a consequence, speech quality can be assured. Therefore, we recommend to use the VLAN feature to perform VoIP communication effectively.

Some IP-PTs (i.e., KX-NT136) are equipped with 2 ports, primary and secondary, for packet communication. Allocating these ports to different VLANs enables you to split the paths for packets depending on whether the packet contains voice signals or data.

VLAN settings (VLAN ID and VLAN priority) for the primary port affect voice data transmitted by the IP-PT, whereas VLAN settings for the secondary port apply to data transmitted by a PC connected to the IP-PT. When sending packets, the IP-PT can attach information on which VLAN the packets are to be transmitted over (VLAN Tagging). The switching hub that receives these packets reads the VLAN information and sends the packets over the appropriate VLAN. This helps to ensure bandwidth for IP-PT voice transmissions.

In this way, an IP-PT with 2 ports can transmit voice packets from the primary port with higher priority than other packets from the secondary port.

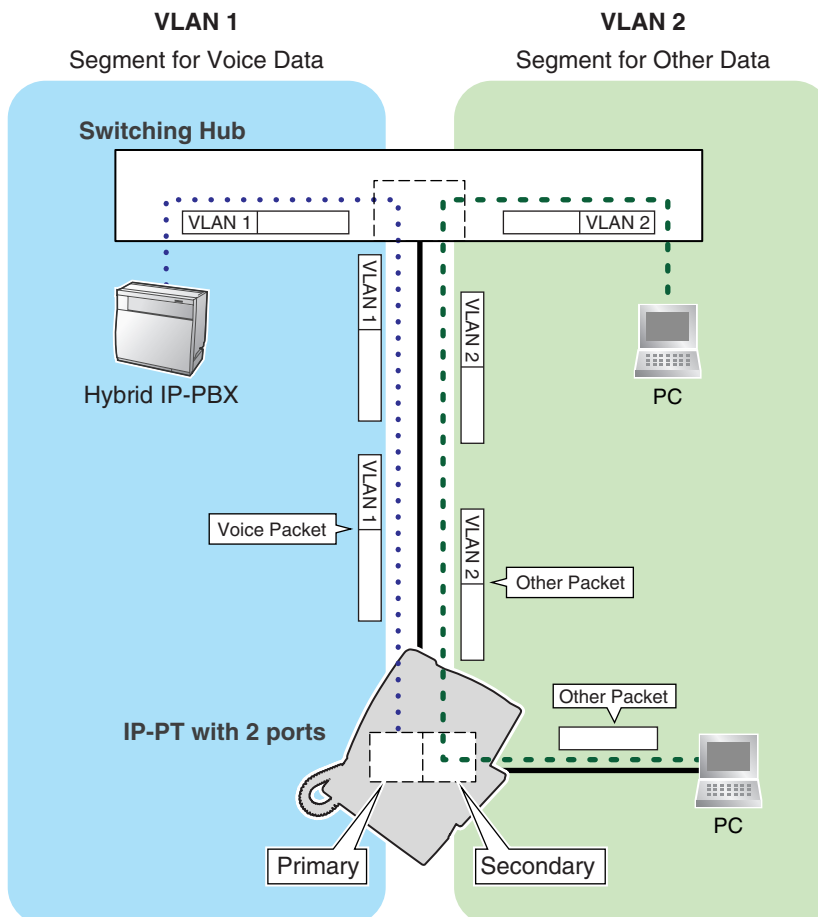

Notes

- This VLAN feature complies with IEEE (Institute of Electrical and Electronics Engineers) 802.1Q.

1.2 Network Management

- The Hybrid IP-PBX receives VLAN settings only from the connected switching hub. Therefore, VLAN settings for the Hybrid IP-PBX must be assigned at the switching hub.
- Some PC LAN cards allow VLAN settings to be assigned. However, when using a PC connected to an IP-PT with 2 ports, the VLAN settings for PC communications must be assigned only to the secondary port of the IP-PT. Any VLAN settings assigned to the PC LAN card must be disabled. These settings can usually be identified by "802.1Q", "802.1p", or "VLAN" in their name.
- If you are using an IP-PT with a primary port only (i.e., KX-NT265), a PC cannot be connected to the IP-PT.

Section 2

Guidance for VoIP Installation

2.1 Vol4P Requirements

2.1.1 Bandwidth Assessment

When using IP-PTs, you must ensure that the IP network in use has enough bandwidth to support VoIP communications. If the amount of bandwidth required for VoIP communications is larger than the network can accommodate, speech quality will be compromised. In addition, there may be an adverse effect on the performance of other applications (e.g., email or web applications) that use the same network. Therefore, care must be taken when assessing bandwidth requirements.

Inform your network administrator of the required bandwidth, and make sure that the network can support VoIP communications even under conditions of maximum network traffic.

Required Bandwidth per IP-PT for a Call

The required bandwidth depends on what combination of CODEC and packet sending interval is used. Keep in mind the following points about the type of CODEC and packet sending interval, in terms of speech quality:

- The speech quality of the G.711 CODEC is higher than that of the G.729a CODEC.
- The shorter the packet sending interval, the higher the speech quality.
- The higher the speech quality the IP-PTs provide, the more bandwidth the IP-PTs require.

CODEC	Packet Sending Interval			
	20 ms	30 ms	40 ms	60 ms
G.711	87.2 kbps	79.5 kbps	—	—
G.729a	31.2 kbps	23.5 kbps	19.6 kbps	15.7 kbps

Required Bandwidth for Each IP-EXT16 Card

To allow all IP-PTs to make calls simultaneously, it is necessary to keep available the bandwidth required by an IP-EXT16 card with the maximum number of IP-PTs connected.

Provided below is the formula to calculate the amount of bandwidth required for each IP-EXT16 card.

Required Bandwidth

$$= (\text{Required Bandwidth per IP-PT} \times 16)$$

2.1.2 Network Configuration

You must evaluate the structure of the existing network to see if a VoIP network can be implemented. Below are the points that should be evaluated.

Is the IP network a managed network?

A VoIP network should be implemented on a managed IP network such as Frame Relay, Leased Line, or IP-VPN (Virtual Private Network).

An unmanaged network, such as the Internet (including an Internet VPN), cannot be used to employ a VoIP network because delays and loss in data transmission can cause huge degradation in speech quality.

Is it possible to have static IP addressing?

IP-PTs on the network must always communicate with each other through the IP-EXT16 card, not directly. Therefore, the card must be assigned a static IP address, which must be programmed to each IP-PT on the network.

Note

When a DHCP server (which automates IP addressing of the IP-PTs on the network) is not used, static IP addressing must also be enabled for all IP-PTs.

Does only a single router provide IP-PT access to the IP network?

In a dual network, 2 routers provide access to the IP network as shown in the diagram below. However, only one router can be used as an access point to the network for all IP-PTs.

Therefore, in the diagram below, if router A, whose IP address is assigned as the default gateway IP address of the IP-PT and IP-EXT16 card, fails, VoIP communications are no longer possible; they are not able to switch their default gateway from router A to router B to access the IP network.

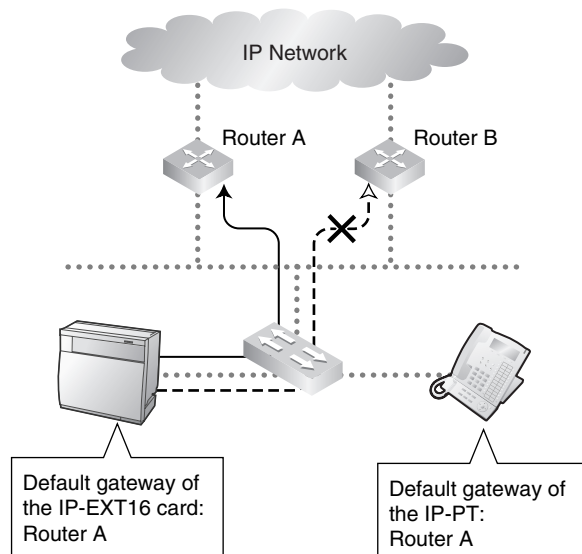

Does the router not use network address translation (NAT/NAPT)?

If the router uses address translation techniques (e.g., NAT/NAPT) to convert between global and local IP addresses, VoIP communications between the IP-EXT16 card and IP-PT cannot be carried out effectively. Therefore, the routers used to access the IP network must not use NAT/NAPT. Generally, NAT and NAPT are features that are available with routers.

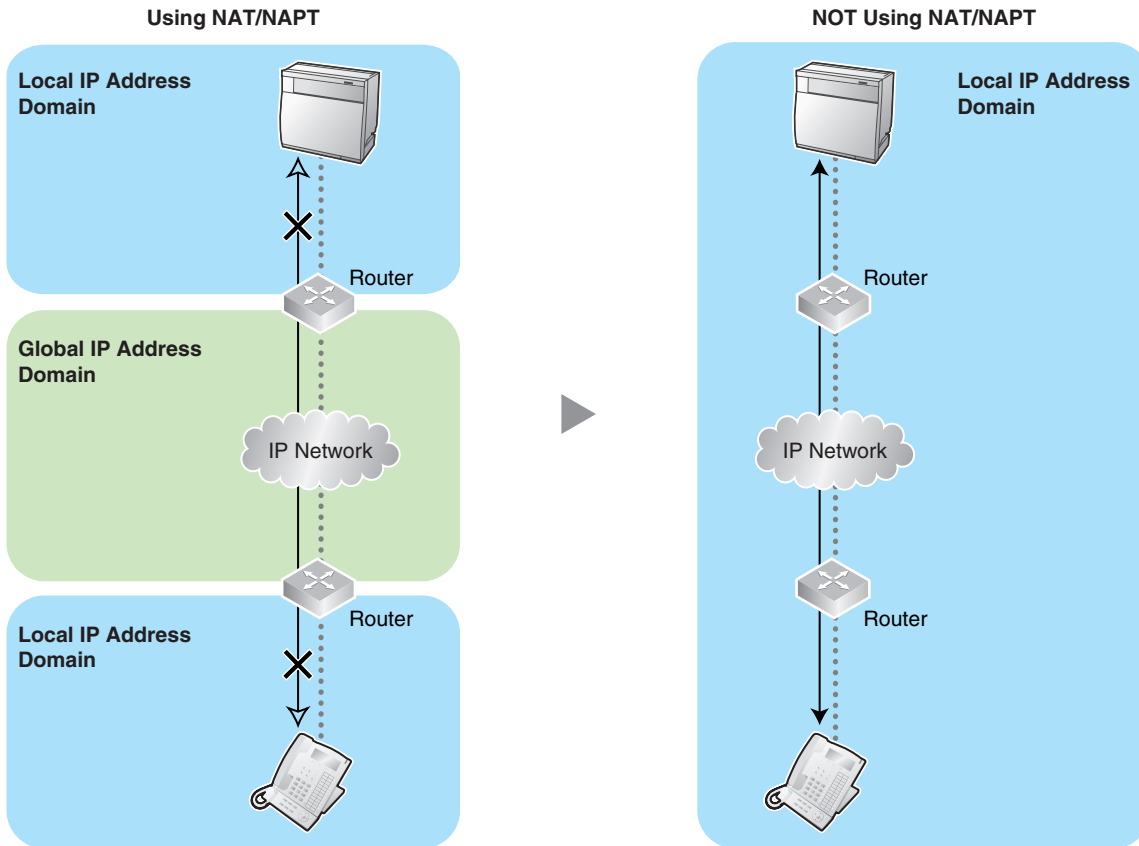

Are the IP-EXT16 card and IP-PTs located appropriately?

Transmission delays can cause pauses and loss in VoIP communications. The more routers there are between the IP-EXT16 card and IP-PTs, the longer the transmission delays, because a certain amount of delay is inevitable when packets pass through each router.

Additionally, the more switching hubs between the card and IP-PTs, the longer the transmission delays, because the switching hubs must also handle the network traffics generated by other terminal devices (e.g., PCs) connected to them.

To prevent unnecessary delays, it is recommended to connect the card and IP-PTs so that there are as few network devices (e.g., routers, switching hubs) between them as possible.

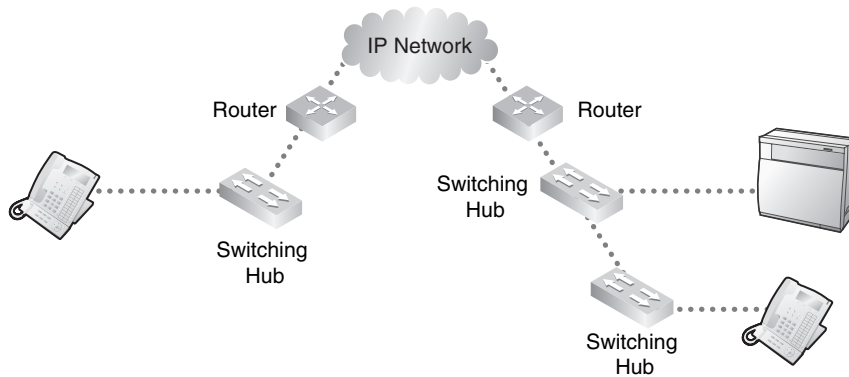

2.1.3 Network Devices

You must evaluate the network devices that are used in the existing network to see if a VoIP network can be implemented. Below are the points that should be evaluated.

Can the firewall pass packets from IP-PTs?

If the VoIP network contains a firewall, the firewall must be configured appropriately to allow VoIP packets, listed in the table below, to pass through the network without being blocked by filtering.

For more information, consult your network administrator.

Protocol	Description	TCP/UDP	Default Port No.
RTP (IP-EXT16)	Real-time Transport Protocol. Used for voice data transmission.	UDP	8000 to 8063
RTP (IP-PT)		UDP	8000 to 8063
Maintenance (IP-EXT16)	Panasonic proprietary protocol. Used for communication parameter negotiation with the PBX, download of country/area data, confirmation of connection with the PBX, and notification of error messages and statistical information to the PBX.	UDP	9300
Maintenance (IP-PT)		UDP	9301
MGCP (IP-EXT16)	Media Gateway Control Protocol. Used for call control command data and LCD/LED data transmission.	UDP	2727
MGCP (IP-PT)		UDP	2427

Protocol	Description	TCP/UDP	Default Port No.
DHCP	Dynamic Host Configuration Protocol. Used for receiving an IP address from a DHCP server.	UDP	67, 68
FTP (Port mode)	File Transfer Protocol. Used for receiving a data file from a FTP server to upgrade the firmware version.	TCP	20, 21

Are layer 2 or 3 switches used?

Use of repeater hubs can increase the network load, and therefore may result in degradation in speech quality.

To ensure high speech quality, use only layer 2 or 3 switches when connecting the IP-EXT16 card to the LAN. Use of layer 2 or 3 switches for connection is also strongly recommended for IP-PTs.

Note

Note that the port of the switching hub that connects to the IP-EXT16 card should be set to operate under "Auto Negotiation" mode.

Are Category 5 (CAT5) or higher cables used?

When connecting network devices, make sure to use CAT5 or higher cables. If other types of cables are used, communications may not be carried out normally.

2.2 VoIP Requirements Checklist

Use the following checklists to see if you can implement a VoIP network. The answers identified in **underlined bold-face letters** are the required answers for the corresponding questions.

Bandwidth Assessment

No.	Question	Answer	Memo	Ref.
1	<p>Does the network have enough bandwidth to support VoIP communications?</p> <p>Make sure that there is more bandwidth available for VoIP communications than the amount actually required.</p>	<input type="checkbox"/> <u>Yes</u> <input type="checkbox"/> No	<ul style="list-style-type: none"> • IP network bandwidth = kbps • Available bandwidth for VoIP = kbps • Required bandwidth for VoIP = kbps 	p. 12

Network Configuration

No.	Question	Answer	Memo	Ref.
2-a	<p>Is the IP network a managed network?</p> <p>Make sure to use a managed IP network such as Frame Relay, Leased Line, or IP-VPN (Virtual Private Network). The IP-EXT16 card is not intended for use on the Internet (including an Internet VPN).</p>	<input type="checkbox"/> <u>Yes</u> <input type="checkbox"/> No	Type of IP network:	p. 12
2-b	<p>Is it possible to have static IP addressing?</p>	<input type="checkbox"/> <u>Yes</u> <input type="checkbox"/> No		p. 13
2-c	<p>Does only a single router provide IP-PT access to the IP network?</p>	<input type="checkbox"/> <u>Yes</u> <input type="checkbox"/> No		p. 13
2-d	<p>Does the router not use network address translation (NAT/NAPT)?</p>	<input type="checkbox"/> <u>Yes</u> <input type="checkbox"/> No		p. 14
2-e	<p>Are the IP-EXT16 card and IP-PTs located appropriately?</p> <p>It is recommended to connect the card and IP-PTs as close to each other on the network as possible.</p>	<input type="checkbox"/> <u>Yes</u> <input type="checkbox"/> No		p. 15

Network Devices

No.	Question	Answer	Memo	Ref.
3-a	<p>Can the firewall pass packets from IP-PTs? When a firewall is used, make sure to configure the firewall appropriately to allow VoIP packets to pass through the network without being blocked by filtering.</p>	<input type="checkbox"/> Yes <input type="checkbox"/> No	Model of firewall:	p. 15
3-b	<p>Are layer 2 or 3 switches used? Do not use repeater hubs as they can increase the network load. Also note that the port of the switching hub that connects to the IP-EXT16 card should be set to operate under "Auto Negotiation" mode.</p>	<input type="checkbox"/> Yes <input type="checkbox"/> No	Model of switch:	p. 16
3-c	<p>Are Category 5 (CAT5) or higher cables used?</p>	<input type="checkbox"/> Yes <input type="checkbox"/> No		p. 16

Section 3

Installation

This section describes the physical installation process of the IP-EXT16 card covering the following topics: (1) installing the card in the Hybrid IP-PBX, and (2) connecting the card and IP-PTs to the LAN.

3.1 Installing the IP-EXT16 Card in the Hybrid IP-PBX

3.1.1 Names and Locations

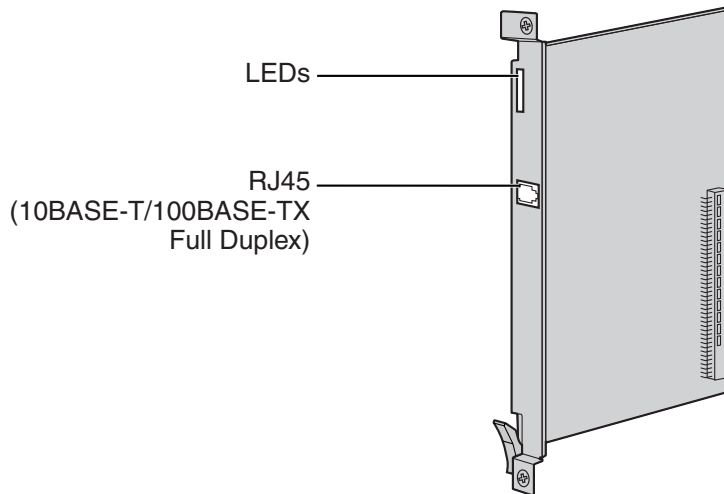

Indication Light (LED)

When the IP-EXT16 card is operating, each LED should show the status identified in **bold-face letters** under normal conditions.

Indication	Color	Description
CARD STATUS	Green/Red	Card status indication <ul style="list-style-type: none"> • OFF: Power Off • Green ON: Normal (all ports are idle) • Green Flashing (60 times per minute): Normal (a port is in use) • Red ON: Fault (includes reset) • Red Flashing (60 times per minute): Out of Service
ONLINE	Green	On-line status indication <ul style="list-style-type: none"> • ON: At least one port is in use (an IP-PT is connected) • OFF: No ports are in use (No IP-PTs are connected) <p>Note If the LINK indicator is OFF, the ONLINE indicator will also be OFF.</p>
ALARM	Red	Alarm indication <ul style="list-style-type: none"> • ON: Alarm • OFF: Normal
VoIP BUSY	Green	Panasonic proprietary VoIP protocol process indication <ul style="list-style-type: none"> • OFF: VoIP process inactive • ON: VoIP process active

Indication	Color	Description
LINK	Green	Link status indication <ul style="list-style-type: none"> • ON: Normal connection • OFF: Connection error
DATA	Green	Data transmission indication <ul style="list-style-type: none"> • ON: Data being transmitted • OFF: No data transmitted

3.1.2 Installation

Install the IP-EXT16 card in a free slot of the Hybrid IP-PBX.

Note

The illustrations of the Hybrid IP-PBX shown in the installation procedure are based on the KX-TDA200.

1. Insert the card along the guide rails.

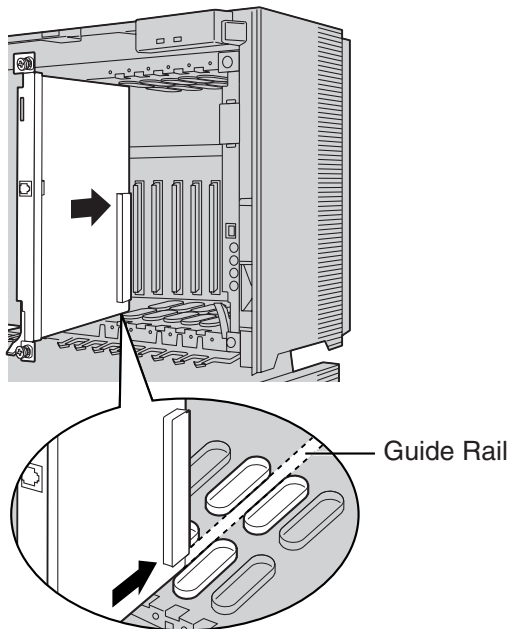

3.1 Installing the IP-EXT16 Card in the Hybrid IP-PBX

2. Holding the card as shown below, push the release lever in the direction of the arrow so that the card engages securely with the connector on the back board.

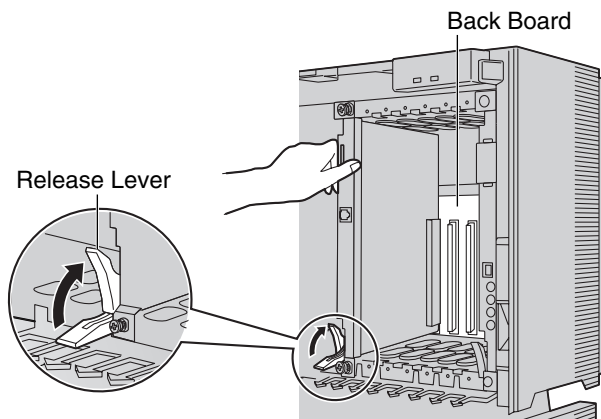

3. Turn the 2 screws clockwise to fix the card in place.

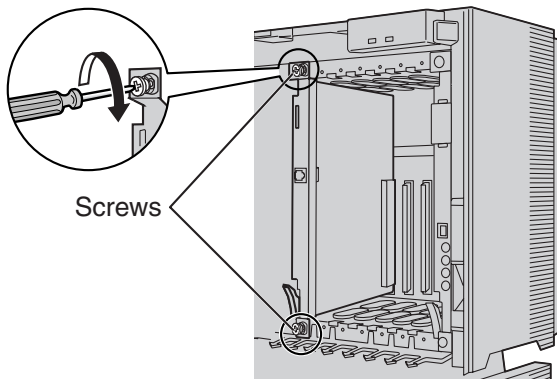

Note

Make sure the screws are tightened to earth the card securely.

3.2 Connecting to the LAN

3.2.1 Connecting the IP-EXT16 Card

Refer to the following example to connect the IP-EXT16 card to the LAN.

When the IP-EXT16 card is connected to the LAN for the first time, you must assign IP addressing information to the card. Refer to "4.1 Programming the IP-EXT16 Card" for instructions.

Notes

- Use an Ethernet straight cable with an RJ45 connector to connect the IP-EXT16 card to a switching hub. The cable should be a 10BASE-T/100BASE-TX CAT5 (Category 5) or higher cable.
 - Before connecting the IP-EXT16 card, attach a ferrite core (included with the card) to the cable.
 - Make sure to set the port of the switching hub that connects to the IP-EXT16 card to operate under "Auto Negotiation" mode.
 - When using the VLAN feature on the network, make sure that the IP-EXT16 card is connected to a layer 2 switch that complies with IEEE 802.1Q, and that is configured for VLANs. In addition, the port of the switching hub to which the IP-EXT16 card is connected must be set to "Untagged". Consult your network administrator for details.
 - To use a KX-NT265, make sure that the Local Processor (LPR) software of the IP-EXT16 card is as follows:
 - PIPEXT Software Version 1.001 or later.
 - PVOIPEX Software Version 1.011 or later.
1. Wrap the cable once around the ferrite core, leaving 5 cm (1-15/16 in) between the ferrite core and the connector.
 2. Close the case of the ferrite core.

Attaching a ferrite core to the cable

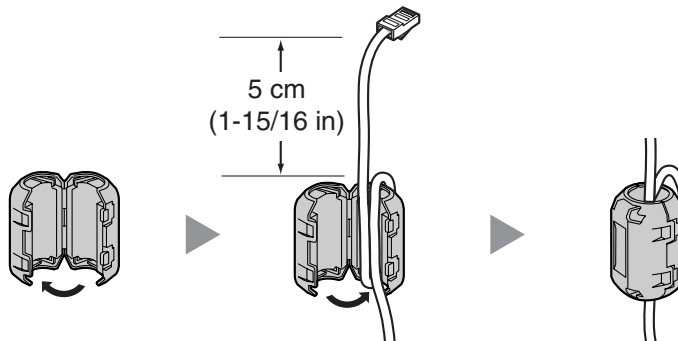

Note

If you need to open the ferrite core, use a flathead screwdriver to unlatch the case.

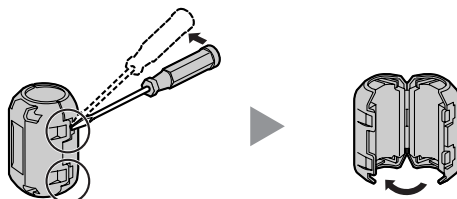

3.2 Connecting to the LAN

3. Connect the cable to the RJ45 connector of the card.
4. Connect the other end of the cable to the switching hub.

Connecting to a switching hub

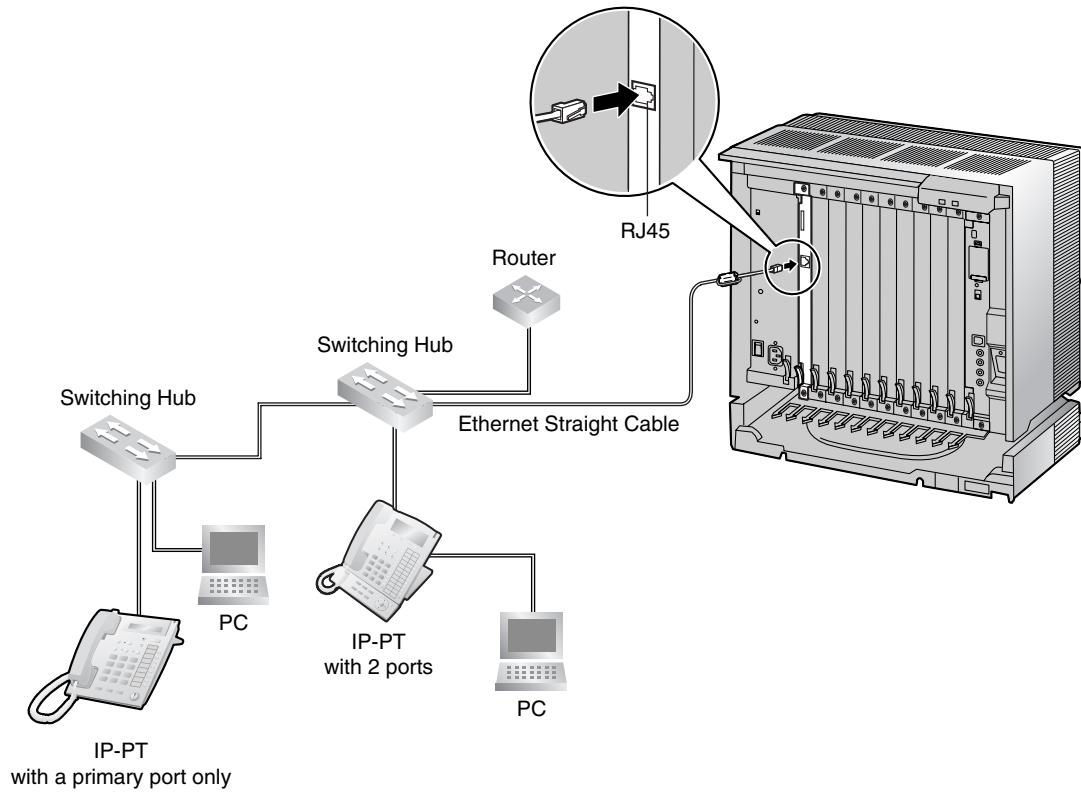

3.2.2 Connecting the IP Proprietary Telephones

When an IP-PT is connected to the LAN and power is supplied for the first time, you will be prompted to set network parameters. The network parameters must be set to the IP-PT before it can be used. Refer to "4.2 Programming the IP Proprietary Telephone" for instructions.

Connecting an IP-PT to a Switching Hub

When connecting an IP-PT to the LAN, connect it to a switching hub.

Notes

- Use an Ethernet straight cable with an RJ45 connector to connect the IP-PT to a switching hub. The cable should be a 10BASE-T/100BASE-TX CAT5 (Category 5) or higher cable.
- When using the VLAN feature on the network, make sure that the switching hub to be connected complies with IEEE 802.1Q and is configured for VLANs. In addition, the port of a switching hub that the IP-PT is connected to must be set to "Trunk" port, to allow VLAN tagging. Consult your network administrator for details.

KX-NT136

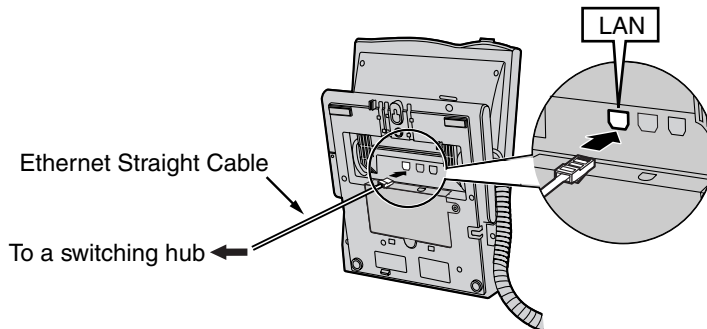

KX-NT265

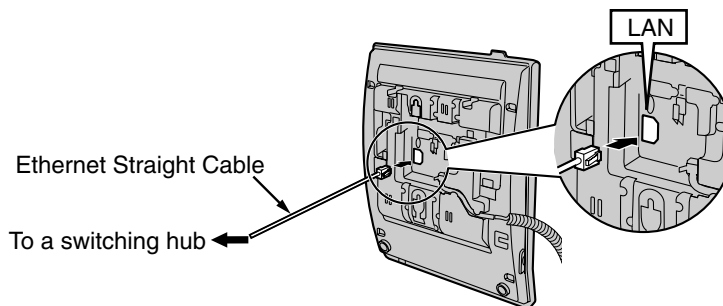

Connecting an AC Adaptor to an IP-PT

IP-PTs comply with IEEE 802.3af Power-over-Ethernet (PoE) feature. If PoE is available on your network, the IP-PT can receive the necessary power supply from the network through the network cable. In this case, no AC adaptor is needed for the IP-PT.

However, if PoE is not available, you will need to connect an AC adaptor to the IP-PT.

Notes

- Use only the KX-A237 Panasonic AC adaptor for the IP-PT.
- Make sure to connect the AC adaptor firmly to the IP-PT parallel to the nub near the connector. Then, pass the cord through the hook as indicated in the illustration below.

KX-NT136

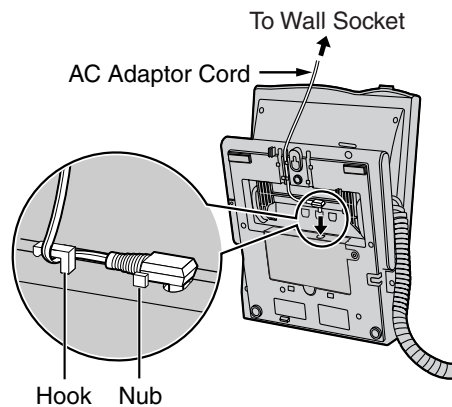

KX-NT265

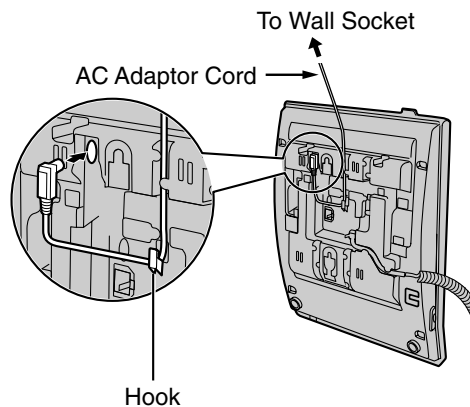

Connecting a PC to an IP-PT (KX-NT136 only)

You can connect a PC to an IP-PT by using the IP-PT's secondary port. In this case, only a single port from the LAN's network interface (switching hub) is required to connect both the IP-PT and PC to the LAN.

Notes

- Use an Ethernet straight cable with an RJ45 connector to connect a PC to the IP-PT. The cable should be a 10BASE-T/100BASE-TX CAT5 (Category 5) or higher cable.
- Only a PC can be connected to the secondary port of an IP-PT. Other IP-PTs, or network devices such as routers or switching hubs, cannot be connected.

- Generally, it is recommended that you connect no more than one PC to the secondary port of each IP-PT.

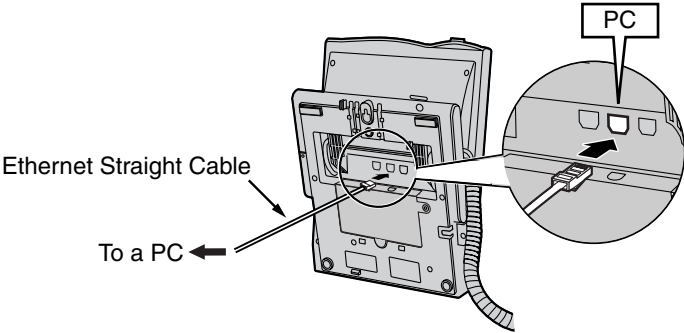

Section 4

Programming

This section describes the process of programming the IP-EXT16 card and IP-PTs covering the following topics: (1) setting network parameters to the card and IP-PTs, and (2) registering the IP-PTs to the Hybrid IP-PBX.

4.1 Programming the IP-EXT16 Card

4.1.1 Assigning the IP Addressing Information

When an IP-EXT16 card is placed on the LAN for the first time, it is necessary to assign IP addressing information to the card. This is done by using the Maintenance Console (KX-TDA100/KX-TDA200: KX-TDA Maintenance Console; KX-TDA600: KX-TDA600 Maintenance Console).

Notes

- It is assumed that you have already installed the Maintenance Console to your PC.
- The programming procedure and screen shots shown in this manual are based on the KX-TDA600 Maintenance Console.
- The contents and design of the software are subject to change without notice.
- Screen shots reprinted with permission from Microsoft Corporation.

1. Start the Maintenance Console from the Start menu.
2. "Information Before Programming" appears.
 - a. Carefully read this important additional information, which includes updates to this and other manuals.
 - b. Click [OK] to close this window.
3. Enter the Installer Level Programmer Code (default: **INSTALLER**).
4.
 - a. Click the check box to connect to the Hybrid IP-PBX.
 - b. Enter the system password for installer (default: **1234**).
 - c. Select "USB", then click [OK].
The programme menu appears.

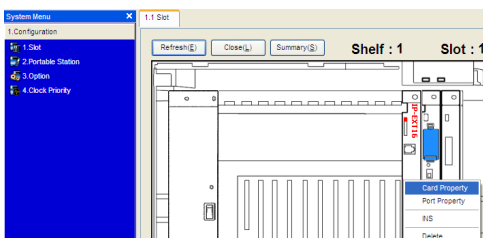
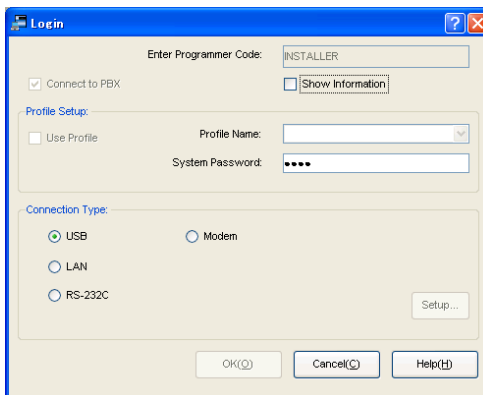
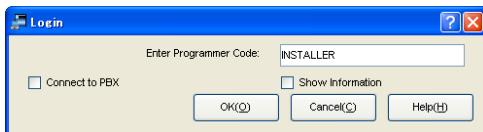

- a. Under **Configuration**, click **Slot**.
- b. Move the mouse pointer over the IP-EXT card. A menu will be shown under the mouse pointer.
- c. Click **OUS** to set the card to out-of-service status.
- d. Move the mouse pointer over the IP-EXT card, then click **Card Property**.

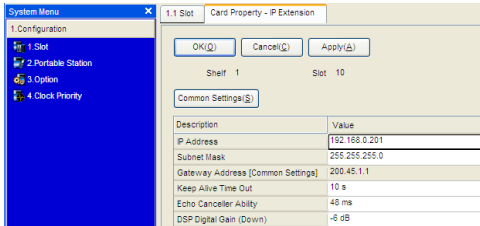

6. a. In the **IP Address** box, type the IP address of the card*¹.
- b. In the **Subnet Mask** box, type the subnet mask address of the network*².
- c. Click [Apply].

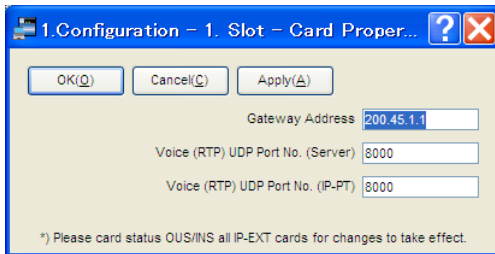

7. If the IP address of the default gateway needs to be entered:
 - a. Click **Common Settings**. A dialog box will appear.
 - b. In the **Gateway Address** box, type the IP address of the default gateway*³.
 - c. Click [OK].

Note

To activate any changes made in step 7, it is necessary to set all installed IP-EXT cards to out-of-service status (**OUS**), then back to in-service status (**INS**).

8. Move the mouse pointer over the IP-EXT card, then click **INS** to set the card to in-service status.

*1 Valid IP address range: "1.0.0.0" to "223.255.255.255"

*2 Valid IP address range: "1.0.0.0" to "255.255.255.254"

*3 Valid IP address range: "0.0.0.0" to "223.255.255.255"

4.2 Programming the IP Proprietary Telephone

4.2.1 Assigning the IP Addressing Information

When Assigning IP Addresses to IP-PTs Using a DHCP Server

When using a DHCP server to automate IP address assignment of IP-PTs, only the IP address of the IP-EXT16 card (PBX IP address) must be entered manually.

Other addresses (i.e., the IP address of the IP-PT, the subnet mask address, and the default gateway address) will be assigned automatically by the DHCP server.

Follow the procedure below for all IP-PTs on the LAN that a DHCP server is used.

If you need to set VLAN parameters, follow the procedure described in "4.2.2 Setting the VLAN Parameters" after assigning the IP addresses without ending programming.

KX-NT136

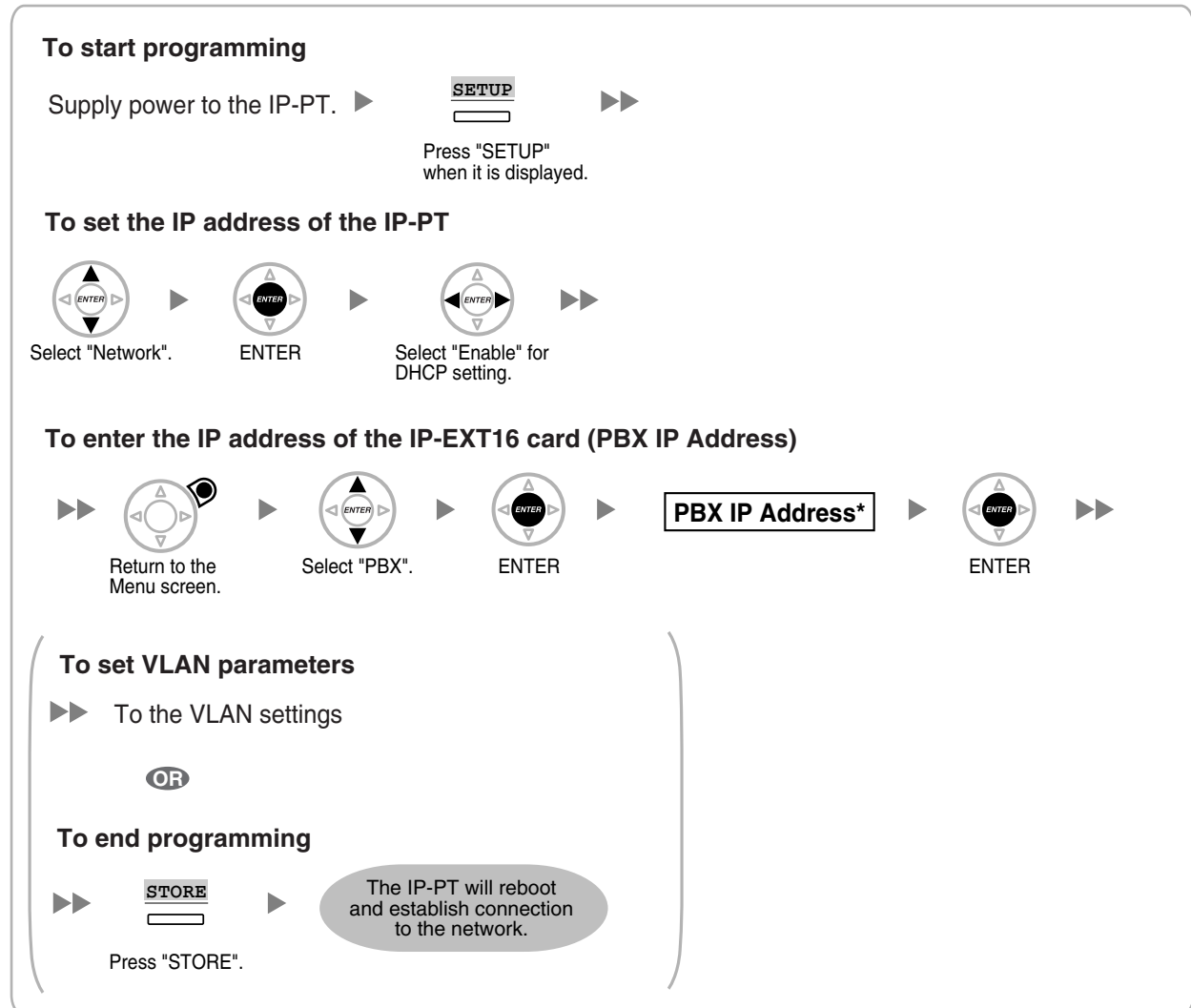

* Valid IP address range: "1.0.0.0" to "223.255.255.255"

KX-NT265

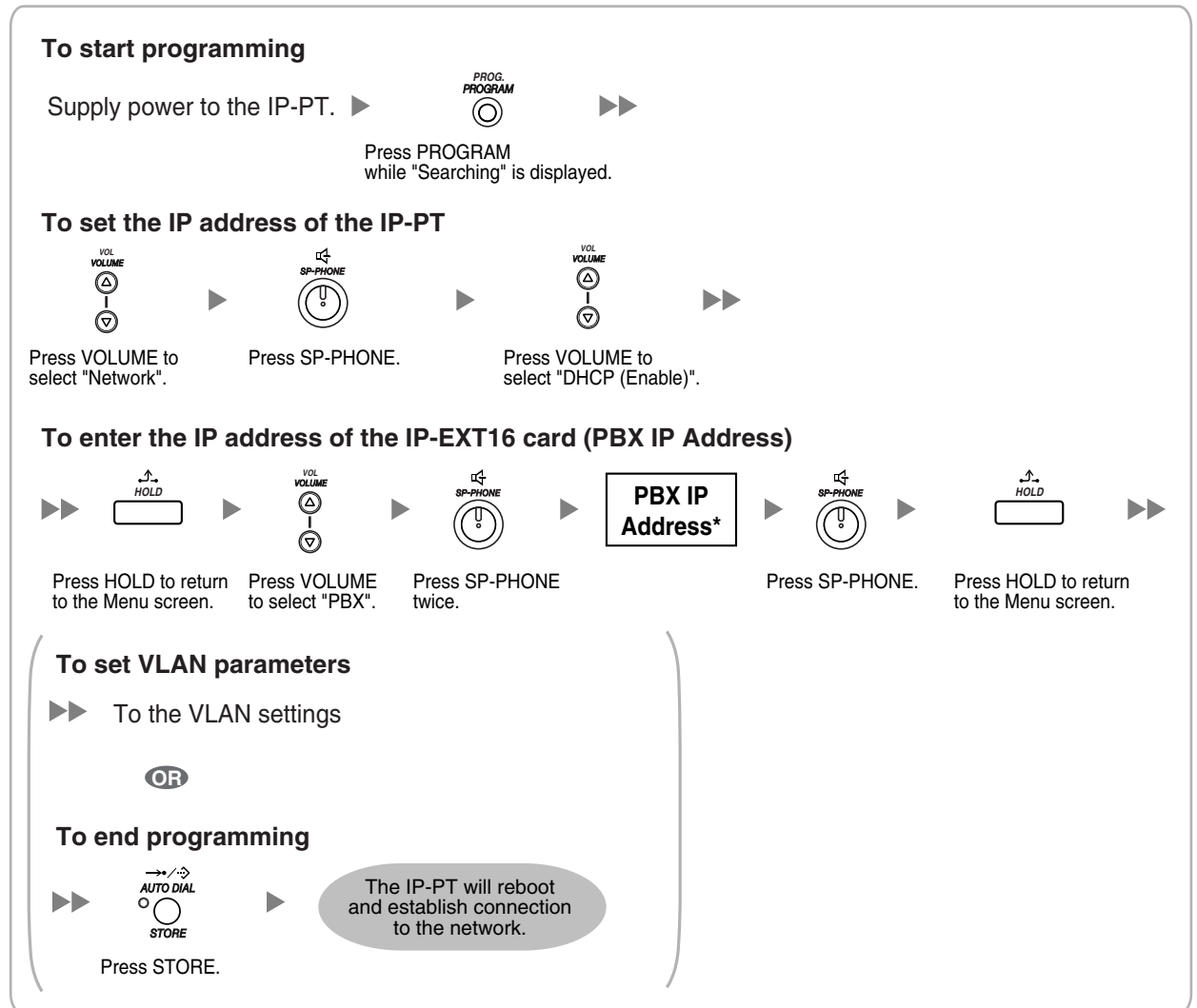

* Valid IP address range: "1.0.0.0" to "223.255.255.255"

When Assigning IP Addresses to IP-PTs Without Using a DHCP Server

If you are not using a DHCP server on the network, you will have to set an IP address and subnet mask address to the IP-PT, in addition to the PBX IP address. If necessary, also enter the IP address of the default gateway.

Follow the procedure below for all IP-PTs on the network, using appropriate IP addressing information. If you need to set VLAN parameters, follow the procedure described in "4.2.2 Setting the VLAN Parameters" after assigning the IP addresses without ending programming.

KX-NT136

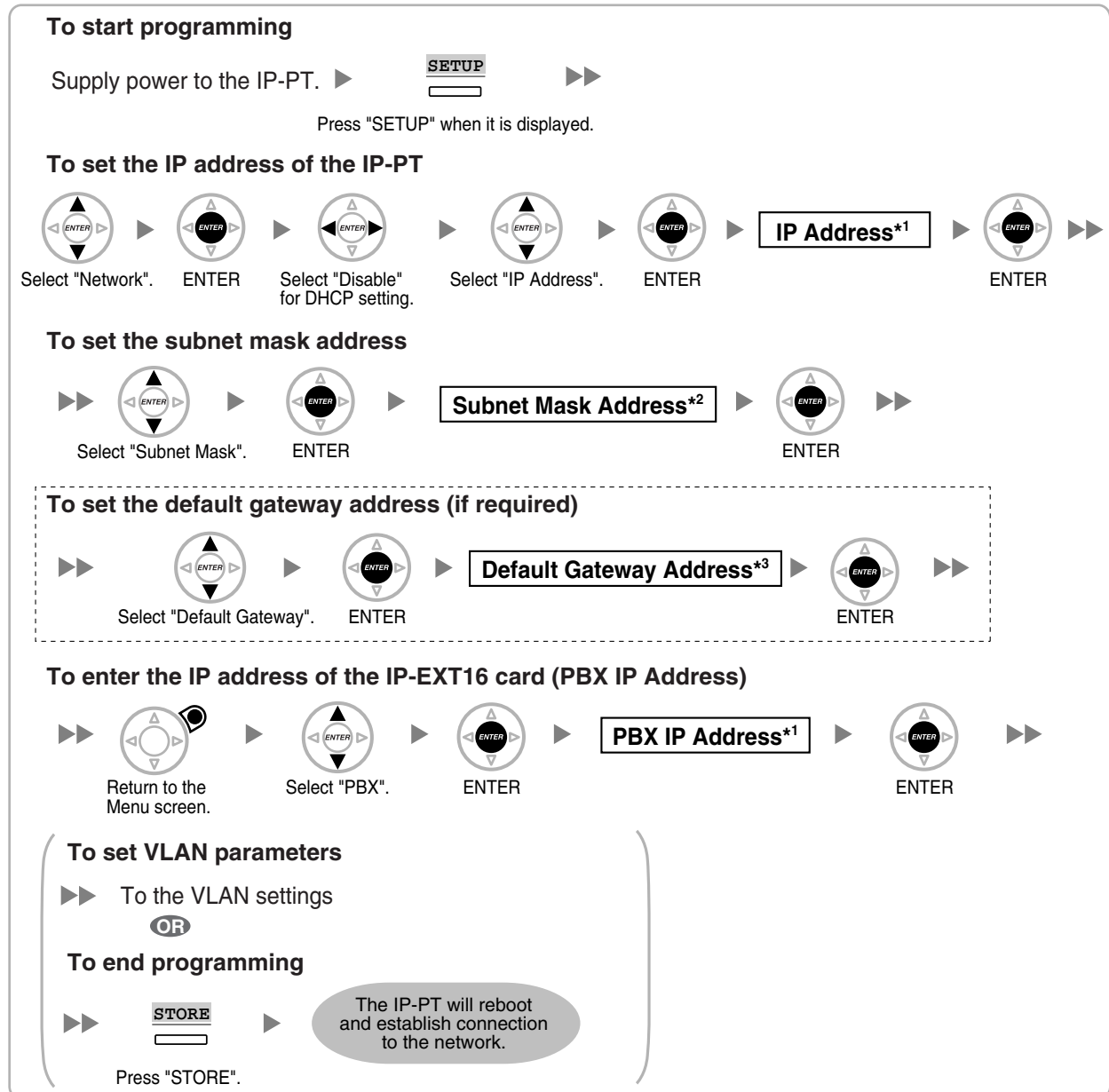

*1 Valid IP address range: "1.0.0.0" to "223.255.255.255"

*2 Valid IP address range: "1.0.0.0" to "255.255.255.254"

*3 Valid IP address range: "0.0.0.0" to "223.255.255.255"

KX-NT265

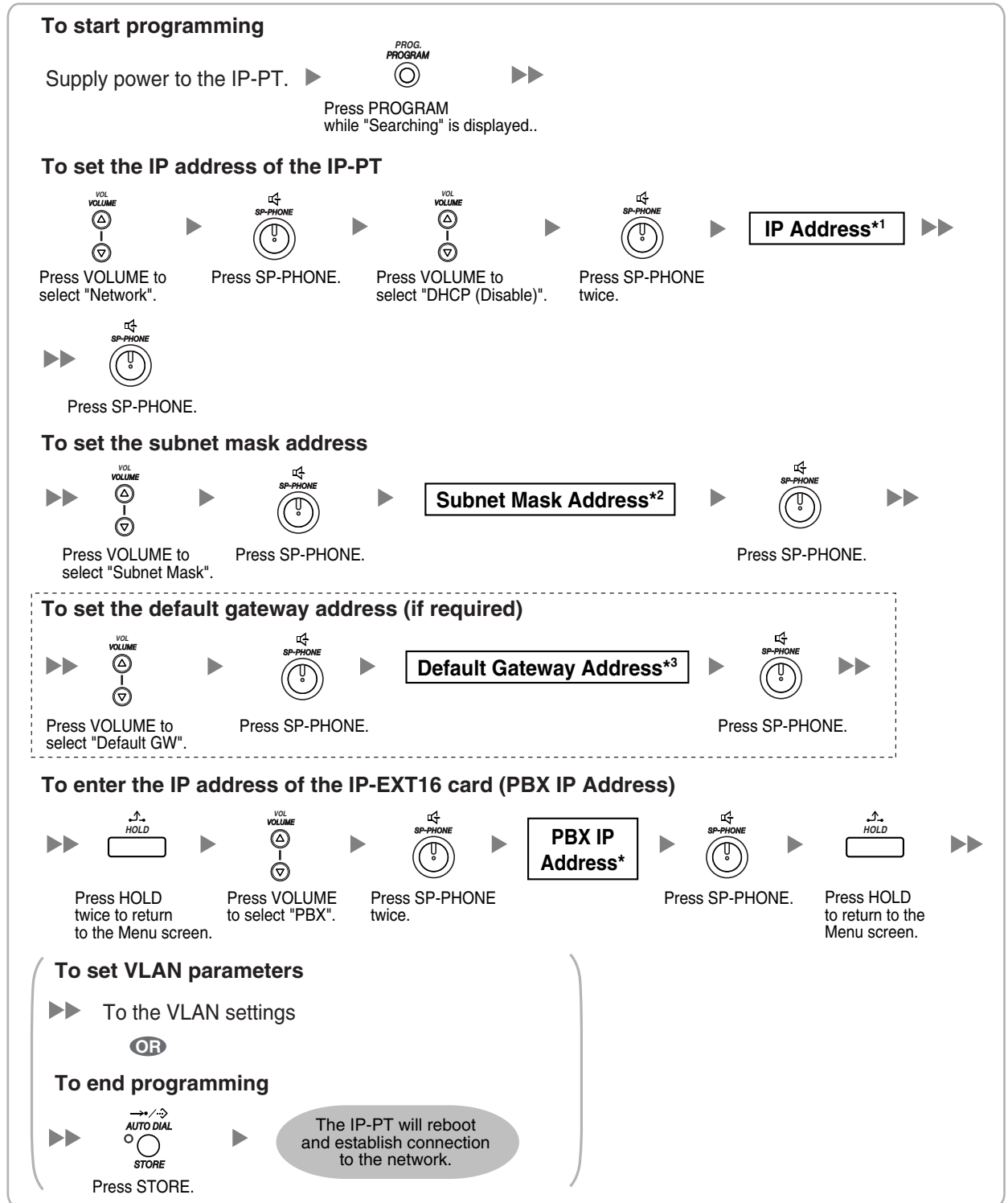

*1 Valid IP address range: "1.0.0.0" to "223.255.255.255"

*2 Valid IP address range: "1.0.0.0" to "255.255.255.254"

*3 Valid IP address range: "0.0.0.0" to "223.255.255.255"

KX-NT265

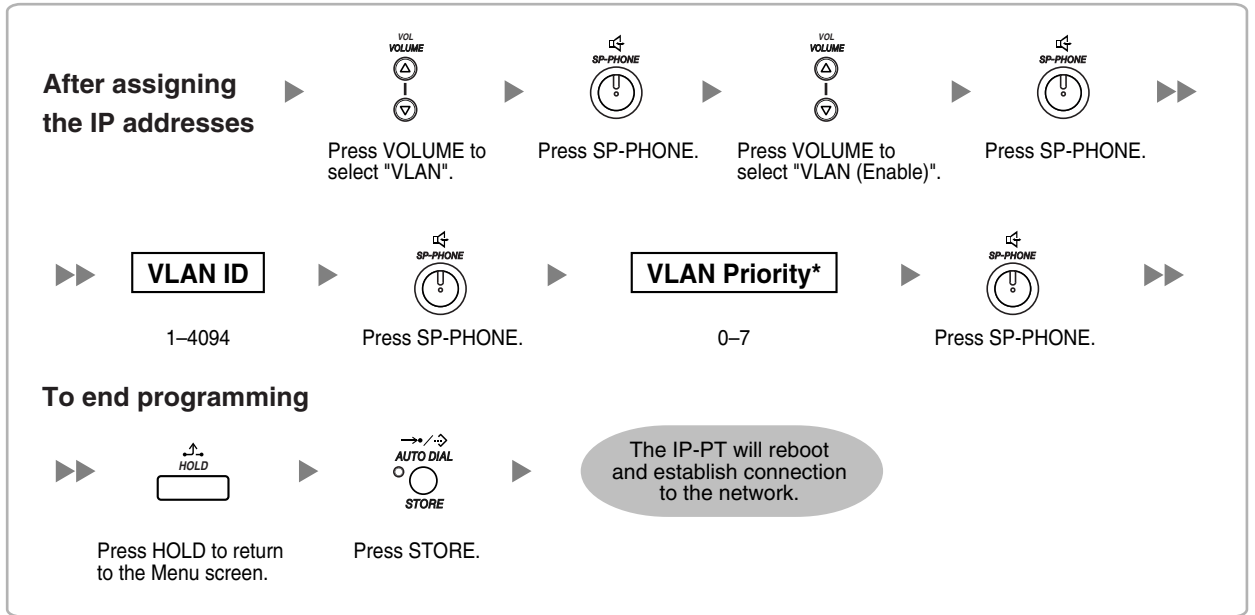

4.3 Registering the IP Proprietary Telephone

4.3.1 Registering the IP-PT

After programming of both the IP-EXT16 card and IP-PT is finished, the IP-PT must be registered to the Hybrid IP-PBX. This is done by using the Maintenance Console.

Registration

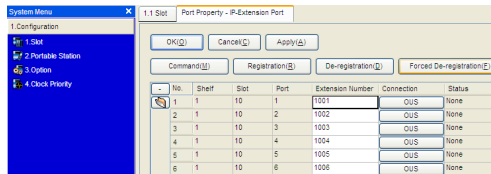

1. **a.** Under **Configuration**, click **Slot**.
- b.** Move the mouse pointer over the IP-EXT card. A menu will be shown under the mouse pointer.
- c.** Click **Port Property**.

2. Click **Registration**.
A dialog box will appear. Non-registered (available) extension numbers are displayed on the left.

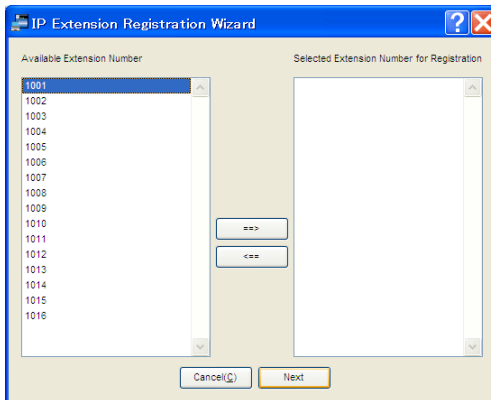

3. **a.** Highlight numbers and click the right arrow to select them for registration.
- b.** Click **Next**. A screen will appear with information on the current IP-PT extension number and index number for programming.
- c.** Click **Next**.
 - If the registration is still in process, the dialog box will show "Waiting for IP-PT to register...". Click **OK**.
 - If the registration is successful, the dialog box will show "Registration Succeed". If there are more IP-PTs to be registered, click **Continue** to resume or **Cancel** to terminate the registration. If not, click **Close**.

Once the IP-PT is successfully registered, the status of the IP-PT will update to show "Registered".

4.3.2 De-registering the IP-PT

De-registration

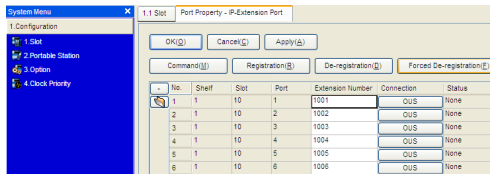

1. a. Under **Configuration**, click **Slot**.
 b. Move the mouse pointer over the IP-EXT card. A menu will be shown under the mouse pointer.
 c. Click **Port Property**.
2. Click **De-registration**.
 A dialog box will appear. Registered extension numbers are displayed on the left.
3. a. Highlight numbers and click the right arrow to select them for de-registration.
 b. Click **Next**.
 A dialog box will appear.
 c. Click **Confirm**.
 - If the de-registration is successful, the dialog box will show "De-registration Succeed".
 d. Click **Close**.



Once the IP-PT is successfully de-registered, the status of the IP-PT will update to show "None".

Forced De-registration

Follow the steps below to forcibly de-register the IP-PT when normal de-registration has been unsuccessful.

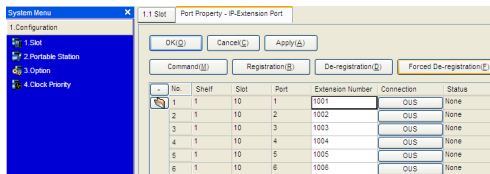

1. a. Under **Configuration**, click **Slot**.
 b. Move the mouse pointer over the IP-EXT card. A menu will be shown under the mouse pointer.
 c. Click **Port Property**.
2. Click **Forced De-registration**.
 A dialog box will appear. Registered extension numbers are displayed on the left.

4.3 Registering the IP Proprietary Telephone

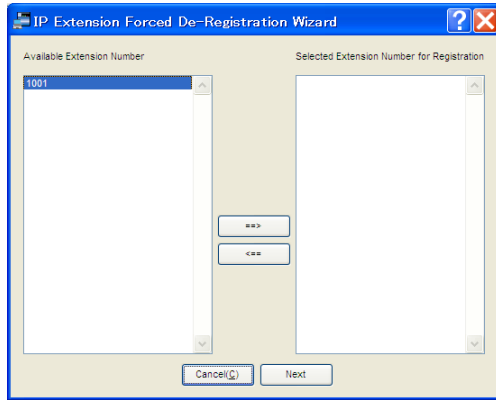

3.
 - a. Highlight numbers and click the right arrow to select them for de-registration.
 - b. Click **Next**.
A dialog box will appear.
 - c. Click **OK**.
A dialog box will appear.
 - d. Click **Confirm**.
 - If the de-registration is successful, the dialog box will show "Forced De-registration Succeed".
 - e. Click **Close**.

Once the IP-PT is successfully de-registered, the status of the IP-PT will update to show "None".

Appendix A

Troubleshooting

A1 Troubleshooting

A1.1 Operation

Problem	Probable Cause	Solution
Cannot set the IP address, subnet mask address, and PBX IP address to the IP-PT.	An unusable value is being set.	<ul style="list-style-type: none"> Set an IP address within the valid range. IP address of the IP-PT/PBX: "1.0.0.0" to "223.255.255.255" Subnet mask address: "1.0.0.0" to "255.255.255.254"
Cannot register the IP-PT.	The necessary network parameters are not set to the IP-PT.	<ul style="list-style-type: none"> When not using a DHCP server, set the IP address, subnet mask address, and enter the PBX IP address. If necessary, also enter the IP address of the default gateway. When using a DHCP server, enter the PBX IP address.
The IP-PT cannot connect to the Hybrid IP-PBX.	The wrong IP address, subnet mask address, PBX IP address, or default gateway address was entered.	<ul style="list-style-type: none"> Check each parameter and enter the correct value.
	The Ethernet cable is not connected correctly.	<ul style="list-style-type: none"> Check the Ethernet cable connections.
	The DHCP server is not active.	<ul style="list-style-type: none"> Restart the DHCP server. Disable DHCP and re-enter settings as appropriate (refer to "4.2.2 Setting the VLAN Parameters").

A1.2 Error Message

When a major system error occurs, an error message is displayed on the IP-PT.

KX-NT136

Error Message & IP-PT Activity	Probable Cause	Solution
ERR 1001-XXXX HARDWARE ERROR Displays error and stops operating.	<ul style="list-style-type: none"> Sub CPU malfunction 	<ul style="list-style-type: none"> Repair or replace the IP-PT.
ERR 1002-XXXX HARDWARE ERROR Displays error and stops operating.	<ul style="list-style-type: none"> Sound hardware malfunction 	
ERR 1003-XXXX HARDWARE ERROR Displays error and stops operating.	<ul style="list-style-type: none"> Flash memory malfunction 	
ERR 2001-XXXX SYSTEM ERROR Resets and displays error for 5 seconds while starting up.	<ul style="list-style-type: none"> Unexpected error 	<ul style="list-style-type: none"> If this error is displayed frequently, repair or replace the IP-PT.
ERR 2002-XXXX POOR LAN CONNECTION Resets and displays error for 5 seconds while starting up.	<ul style="list-style-type: none"> Transmission error 	<ul style="list-style-type: none"> Check with the network administrator whether there is a problem with the LAN. If this error is displayed frequently, repair or replace the IP-PT.
ERR 2003-XXXX POOR LAN CONNECTION Resets and displays error for 5 seconds while starting up.		
ERR 2004-XXXX UNREGISTERED TO SERVER Resets and displays error for 5 seconds while starting up.	<ul style="list-style-type: none"> IP-PT not registered 	<ul style="list-style-type: none"> Check the registration status of the IP-PT.
ERR 2005-XXXX NO MORE CONNECTIONS Resets and displays error for 5 seconds while starting up.	<ul style="list-style-type: none"> Connection refused by the Hybrid IP-PBX 	
ERR 2006-XXXX DHCP SERVER REJECTION Resets and displays error for 5 seconds while starting up.	<ul style="list-style-type: none"> IP address lease time from DHCP server has expired IP address lease renewal was refused by DHCP server 	<ul style="list-style-type: none"> Consult your network administrator.
ERR 2007-XXXX HARDWARE ERROR Resets and displays error for 5 seconds while starting up.	<ul style="list-style-type: none"> Communication error with sub CPU 	<ul style="list-style-type: none"> If this error is displayed frequently, repair or replace the IP-PT.

KX-NT136

Error Message & IP-PT Activity	Probable Cause	Solution
ERR 2008-XXXX HARDWARE ERROR Resets and displays error for 5 seconds while starting up.	<ul style="list-style-type: none"> Sound hardware control error 	<ul style="list-style-type: none"> If this error is displayed frequently, repair or replace the IP-PT.
ERR 2009-XXXX MGCP SERVER REJECTION Resets and displays error for 5 seconds while starting up.	<ul style="list-style-type: none"> Error information from the Hybrid IP-PBX (MGCP server) 	<ul style="list-style-type: none"> Consult your network administrator.
ERR 3001-XXXX HARDWARE ERROR Displays error until reset the IP-PT.	<ul style="list-style-type: none"> Communication error with sub CPU 	<ul style="list-style-type: none"> If this error is displayed frequently, repair or replace the IP-PT.
ERR 3002-XXXX HARDWARE ERROR Displays error until reset the IP-PT.	<ul style="list-style-type: none"> Sound hardware control error 	

KX-NT265

Error Message & IP-PT Activity	Probable Cause	Solution
ERR 1002-0000 Displays error and stops operating.	<ul style="list-style-type: none"> Sound hardware malfunction 	<ul style="list-style-type: none"> Repair or replace the IP-PT.
ERR 1003-0000 Displays error and stops operating.	<ul style="list-style-type: none"> Flash memory malfunction 	
ERR 1004-XXXX Displays error and stops operating.	<ul style="list-style-type: none"> PHY (network control IC) error 	
ERR 1005-XXXX Displays error and stops operating.	<ul style="list-style-type: none"> SDRAM error 	
ERR 1006-XXXX Displays error and stops operating.	<ul style="list-style-type: none"> SRAM error 	
ERR 2001-XXXX Resets and displays error for 5 seconds while starting up.	<ul style="list-style-type: none"> Unexpected error 	<ul style="list-style-type: none"> If this error is displayed frequently, repair or replace the IP-PT.
ERR 2002-0000 Resets and displays error for 5 seconds while starting up.	<ul style="list-style-type: none"> Transmission error 	<ul style="list-style-type: none"> Check with the network administrator whether there is a problem with the LAN. If this error is displayed frequently, repair or replace the IP-PT.
LAN DISCONNECT Resets and displays error for 5 seconds while starting up.		

KX-NT265

Error Message & IP-PT Activity	Probable Cause	Solution
UNREGISTERED Resets and displays error for 5 seconds while starting up.	<ul style="list-style-type: none"> IP-PT not registered 	<ul style="list-style-type: none"> Check the registration status of the IP-PT.
NO MORE CONNECT Resets and displays error for 5 seconds while starting up.	<ul style="list-style-type: none"> Connection refused by the Hybrid IP-PBX 	
ERR 2006-XXXX Resets and displays error for 5 seconds while starting up.	<ul style="list-style-type: none"> IP address lease time from DHCP server has expired IP address lease renewal was refused by DHCP server 	<ul style="list-style-type: none"> Consult your network administrator.
ERR 2008-0000 Resets and displays error for 5 seconds while starting up.	<ul style="list-style-type: none"> Sound hardware control error 	<ul style="list-style-type: none"> If this error is displayed frequently, repair or replace the IP-PT.
ERR 2009-XXXX Resets and displays error for 5 seconds while starting up.	<ul style="list-style-type: none"> Error information from the Hybrid IP-PBX (MGCP server) 	<ul style="list-style-type: none"> Consult your network administrator.
ERR 3002-XXXX Displays error until reset the IP-PT.	<ul style="list-style-type: none"> Sound hardware control error 	<ul style="list-style-type: none"> If this error is displayed frequently, repair or replace the IP-PT.
DHCPSVR NOTFOUND Resets and displays error for 5 seconds while starting up.	<ul style="list-style-type: none"> IP address lease renewal was refused by DHCP server 	<ul style="list-style-type: none"> Consult your network administrator.

**Panasonic Consumer Electronics Company,
Division of Panasonic Corporation of North America**

One Panasonic Way, Secaucus, New Jersey 07094

Panasonic Puerto Rico, Inc.

San Gabriel Industrial Park, Ave. 65 de Infantería, Km. 9.5,
Carolina, Puerto Rico 00985

<http://www.panasonic.com/csd>

Copyright:

This material is copyrighted by Panasonic Communications Co., Ltd., and may be reproduced for internal use only. All other reproduction, in whole or in part, is prohibited without the written consent of Panasonic Communications Co., Ltd.

© 2005 Panasonic Communications Co., Ltd. All Rights Reserved.